

# EVLUMA AREAMAX®

LED STREET, AREA AND SECURITY LIGHTING  
REPLACES HID LUMINAIRES 100-250W

Now  
with more  
lumens!

**AX 30**  
**AX 40**  
**AX 55**  
**AX 70**  
**AX 100**

## DESCRIPTION

The AreaMax LED luminaire for street and area lighting is a robust, utility-grade luminaire designed to last for years. Easy to install, the AreaMax saves energy and maintenance time. Perfect for residential street lighting, parking lots, or rural security applications requiring either full cutoff, or maximal visibility with a diffuse, low-glare light. AreaMax ship with Photocontrol Failsafe™ built-in and the option to activate ConnectLED™ features with the purchase of the Evluma custom Bluetooth application. A dimmable driver, 0-10V, comes standard.

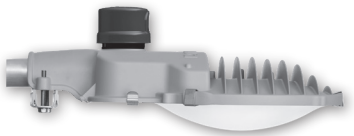

reuse existing photocell  
with S3 option (dome lens shown)

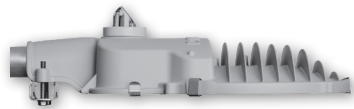

Evluma integrated photocell with P  
option (flat lens shown)

## Construction & Finish

Cast aluminum housing with gray powder coat. Hinged access panel is galvanized steel with spring clips to allow for easy open and close. Color by custom order. Add suffix -BLK for black or -BRZ for bronze.

## Optical (lens)

AreaMax is the original low-glare luminaire. A textured glass drop or flat lens with a white, optical-grade reflective film liner combine to create a bright yet low-glare, diffuse light.

## Electrical

Evluma proprietary Class II driver. 0-10V Dimming. Patented. 120-277 VAC 50/60 Hz high capability surge protection for 20kV/10kA per ANSI C136.2 - 2018 Extreme Location Category C-High.

## Thermal Management

LED life is ensured by thermal management protection circuitry that controls current levels to the LEDs based on temperature. Critical components were selected for their minimal thermal resistance then paired with a custom light engine and casting design to maximize cooling.

## Mounting

Stainless steel tenon clamp and stainless steel screws accept 2" (5.08 cm), or 1 1/4" (3.17 cm) diameter arm.

## Integrated Photocell

Evluma's robust integrated photocell shortens installation time. This UV-resistant, polycarbonate photocell meets FM 4473 impact resistance.

## ConnectLED™

Unlock additional savings with ConnectLED. ConnectLED uses Bluetooth BLE to securely control individual luminaires. Quickly connect or disconnect a luminaire from service. Resolve light trespass or glare complaints with dimming. Available as an Apple or Android app.

## Photocontrol Failsafe™

When a photocell fails, Photocontrol Failsafe takes over, eliminating a truck roll and guaranteeing dusk-till-dawn operation.

## Lumen Maintenance

L70 (10,000) >55,000

L90 (10,000) >55,000

L70 (TM21) >100,000

LM at 10,000 hours >97%

LM at 100,000 > 83%

LM 80 and ISTMT available at [www.evluma.com](http://www.evluma.com)  
TM 21 calculations available upon request.

## Warranty

Ten-year warranty.



CERTIFICATION DATA  
UL 1598. MET Labs  
IP66. IEC 60598-1  
ASTM D2247-68  
FM 4473  
EPA under 0.5 sq ft  
C136.31-2018 Level2/3G  
ANSI C136.2-2018

ENERGY DATA  
PF >99% at 120 VAC  
THD <10% at 120 VAC  
PF >91% at 277 VAC  
THD <20% at 277 VAC  
<1/2W off-state power  
Driver Lifetime >100,000 hrs  
-40°C Min / 50°C Max AM Temp

SHIPPING DATA  
Single Unit Net/Pkgd = 8lbs/10lbs  
Pallet Qty: 56 units, 600 lbs



# EVLUMA AREAMAX®



## ORDERING INFORMATION

SAMPLE NUMBER: AX-40-50-5-D-S7-CST-6

PRODUCT FAMILY	WATTS	CCT	DISTRIBUTION TYPE	LENS (options)	PCR/PHOTOCELL (options)	ENVIRONMENTAL PACKAGE (options)	LEADS (options)	EXTRA
AX = AreaMax	30 = 30 watts 40 = 40 watts 55 = 55 watts 70 = 70 watts 100 = 100 watts	27 = 2700K 30 = 3000K 40 = 4000K 50 = 5000K	5 = type V 3 = type III	D = dome C = cutoff	P = integrated S3 = 3 pin receptacle S7 = 7 pin receptacle	STD = std outdoor CST = coastal	6 = 66" 10 = 10' 20 = 20' N = none	- CAP shorting cap  - PC1 long life NEMA photocell

### 30W PERFORMANCE

recommended to replace 70-100W HID  
CRI for 2700K = 80, all others >70

Code	Lumens	LM/W	BUG
50 5 (C)	4950	165	B2-U0-G1
50 5 (D)	5100	170	B2-U2-G1
40 5 (C)	4920	164	B2-U0-G1
40 5 (D)	5040	168	B2-U2-G1
30 5 (C)	4800	160	B2-U0-G1
30 5 (D)	4920	164	B2-U2-G1
27 5 (C)	4170	139	B2-U0-G1
27 5 (D)	4290	143	B2-U2-G1
50 3 (C)	5220	174	B2-U0-G1
50 3 (D)	5250	175	B2-U2-G2
40 3 (C)	5190	173	B2-U0-G1
40 3 (D)	5190	173	B2-U2-G2
30 3 (C)	5040	168	B2-U0-G1
30 3 (D)	5070	169	B2-U2-G2
27 3 (C)	4380	146	B1-U0-G2
27 3 (D)	4410	147	B2-U2-G2

### 40W PERFORMANCE

recommended to replace 100-150W HID  
CRI for 2700K = 80, all others >70

Code	Lumens	LM/W	BUG
50 5 (C)	6280	157	B2-U0-G1
50 5 (D)	6560	164	B3-U2-G1
40 5 (C)	6240	156	B2-U0-G1
40 5 (D)	6480	162	B3-U2-G1
30 5 (C)	6080	152	B2-U0-G1
30 5 (D)	6360	159	B3-U2-G1
27 5 (C)	5280	132	B2-U0-G1
27 5 (D)	5520	138	B2-U2-G1
50 3 (C)	6880	172	B2-U0-G2
50 3 (D)	6760	169	B2-U2-G2
40 3 (C)	6840	171	B2-U0-G2
40 3 (D)	6680	167	B2-U2-G2
30 3 (C)	6640	166	B2-U0-G2
30 3 (D)	6520	163	B2-U2-G2
27 3 (C)	5760	144	B2-U0-G1
27 3 (D)	5680	142	B2-U2-G2

### 55W PERFORMANCE

recommended to replace 100-175W HID  
CRI for 2700K = 80, all others >70

Code	Lumens	LM/W	BUG
50 5 (C)	8030	146	B3-U0-G1
50 5 (D)	8525	155	B3-U2-G1
40 5 (C)	7920	144	B3-U0-G1
40 5 (D)	8415	153	B3-U2-G1
30 5 (C)	7755	141	B3-U0-G1
30 5 (D)	8250	150	B3-U2-G1
27 5 (C)	6710	122	B2-U0-G1
27 5 (D)	7150	130	B3-U2-G1
50 3 (C)	8470	154	B2-U0-G2
50 3 (D)	8745	159	B3-U2-G3
40 3 (C)	8360	152	B2-U0-G2
40 3 (D)	8635	157	B3-U2-G3
30 3 (C)	8195	149	B2-U0-G2
30 3 (D)	8470	154	B3-U2-G3
27 3 (C)	7095	129	B2-U0-G2
27 3 (D)	7370	134	B2-U2-G2

### 70W PERFORMANCE

recommended to replace 100-200W HID  
CRI for 2700K = 80, all others >70

Code	Lumens	LM/W	BUG
50 5 (C)	9380	134	B3-U0-G1
50 5 (D)	10,080	144	B3-U2-G2
40 5 (C)	9310	133	B3-U0-G1
40 5 (D)	9940	142	B3-U2-G2
30 5 (C)	9100	130	B3-U0-G1
30 5 (D)	9730	139	B3-U2-G2
27 5 (C)	7840	112	B3-U0-G1
27 5 (D)	8470	121	B3-U2-G1
50 3 (C)	9660	138	B2-U0-G2
50 3 (D)	10,360	148	B3-U2-G3
40 3 (C)	9520	136	B2-U0-G2
40 3 (D)	10,220	146	B3-U2-G3
30 3 (C)	9310	133	B2-U0-G2
30 3 (D)	10,010	143	B3-U2-G3
27 3 (C)	8120	116	B2-U0-G2
27 3 (D)	8680	124	B3-U2-G3

### 100W PERFORMANCE

recommended to replace 150-250W HID  
CRI for 2700K = 80, all others >70

Code	Lumens	LM/W	BUG
50 5 (C)	12,100	121	B3-U0-G2
50 5 (D)	13,000	130	B3-U2-G2
40 5 (C)	11,900	119	B3-U0-G2
40 5 (D)	12,900	129	B3-U2-G2
30 5 (C)	11,600	116	B3-U0-G2
30 5 (D)	12,600	126	B3-U2-G2
27 5 (C)	10,100	101	B3-U0-G1
27 5 (D)	10,600	106	B3-U2-G2
50 3 (C)	12,600	126	B3-U0-G3
50 3 (D)	13,400	134	B3-U3-G3
40 3 (C)	12,500	125	B3-U0-G3
40 3 (D)	13,300	133	B3-U3-G3
30 3 (C)	12,200	122	B3-U0-G3
30 3 (D)	13,000	130	B3-U3-G3
27 3 (C)	10,600	106	B3-U0-G3
27 3 (D)	10,900	109	B3-U2-G3



All AreaMax are listed on the DLC QPL.  
For a list of DLC Premium vs. DLC Standard,  
please visit: [designlights.org/qpl](http://designlights.org/qpl).



Dark Sky Approved  
We are proud to offer multiple  
AreaMax models that have  
received the Dark Sky Seal of  
Approval.

Flat lens models (C) with U0, offered in 3000K or  
2700K are IDA compliant. [www.darksky.org](http://www.darksky.org)

Nominal lumen values reported.  
Normal tolerance ± 10%. Individual fixtures may vary  
with LED bin variance and ambient temperatures.

# EVLUMA AREAMAX<sup>®</sup>

## DIMENSIONS (inches)

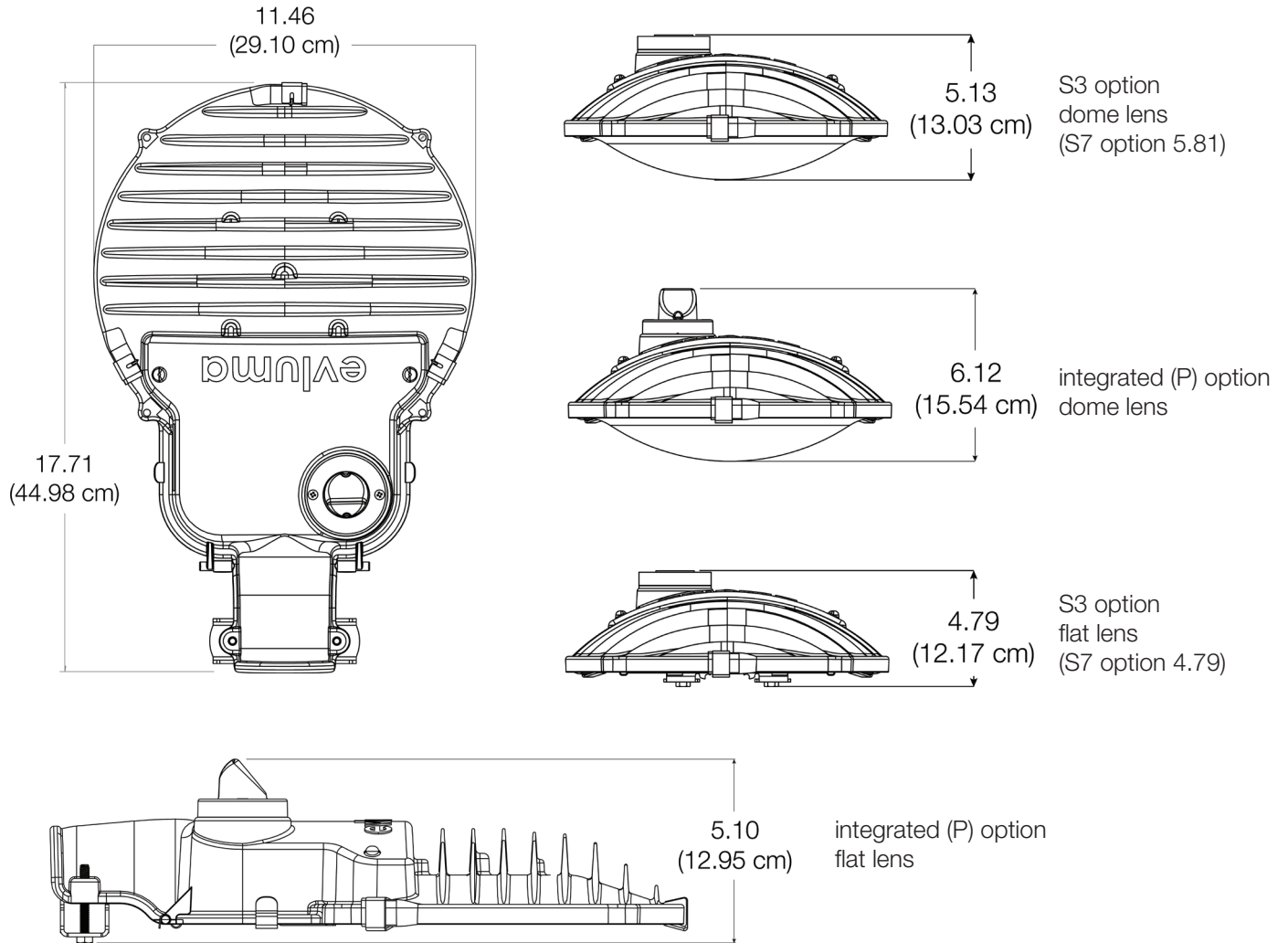

### Accessories

**AX-LTS4** Unfinished aluminum light trespass shield (order separately)

### Coastal Environmental Package Option

Corrosive coastal environments have unique requirements. A housing made from a low copper content, cast aluminum alloy plus an aluminum access panel, a stainless steel tenon clamp and all stainless steel fasteners guarantee longevity in harsh, wet environments. Required for applications 2000 ft. from a salt water body. Salt Spray (Fog) Test 3000 hrs.

Components	Standard	Coastal
<b>Housing</b>	cast aluminum alloy	cast aluminum alloy (low copper content)
<b>Coating</b>	polyester powder coat	polyester powder coat
<b>Access Panel</b>	galvanized steel	aluminum
<b>Tenon Clamp</b>	stainless steel	stainless steel
<b>Bolts</b>	stainless steel	stainless steel

Copyright © 2024 Express Imaging Systems, LLC. Evluma, AreaMax, ConnectLED, and Photocontrol Failsafe are trademarks of Express Imaging Systems, LLC. All rights reserved. For informational purpose only. MET labs logo is a registered trademark of MET labs.

# EVLUMA AREAMAX®

## SAMPLE DISTRIBUTIONS OF LUMINOUS INTENSITY

For complete photometrics on all wattages and CCT, please visit our website.

### 30W Type V & III Dome

30W 50 5-D Dome Lens

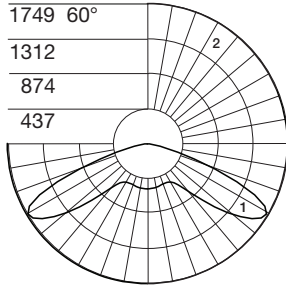

30W 50 3-D Dome Lens

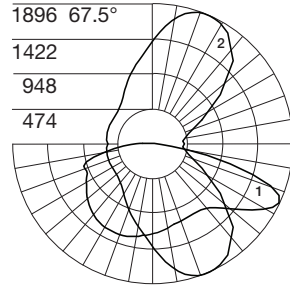

Isofootcandle Lines of Horizontal Illuminance. 25ft Mounting Height

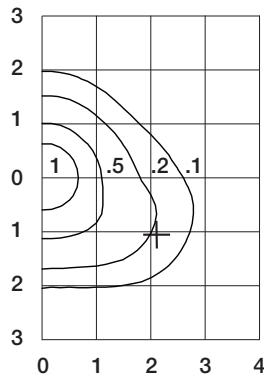
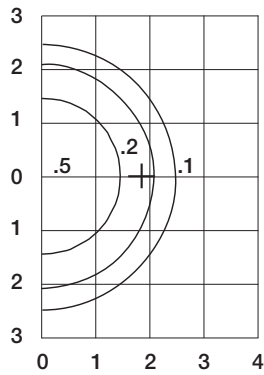

### 55W Type V & III Dome

55W 50-5-D Dome Lens

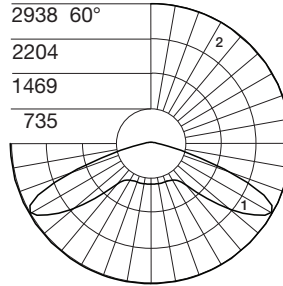

55W 50-3-D Dome Lens

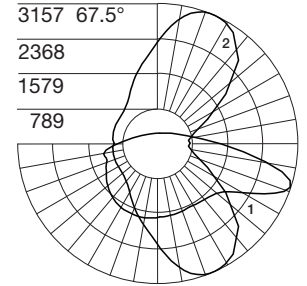

Isofootcandle Lines of Horizontal Illuminance. 25ft Mounting Height

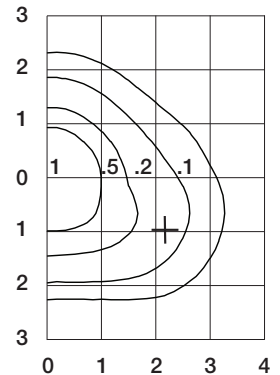
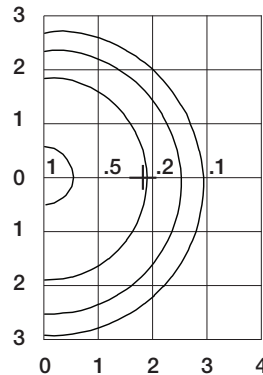

### 70W Type V & III Dome

70W 50 5-D Dome Lens

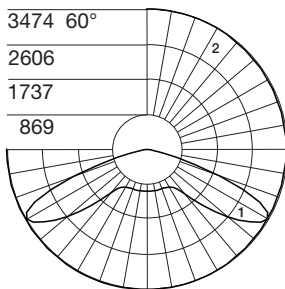

70W 50 3-D Dome Lens

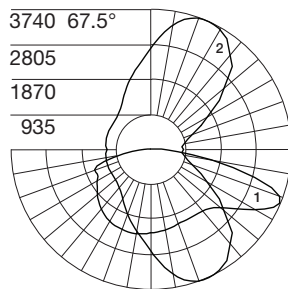

Isofootcandle Lines of Horizontal Illuminance. 25ft Mounting Height

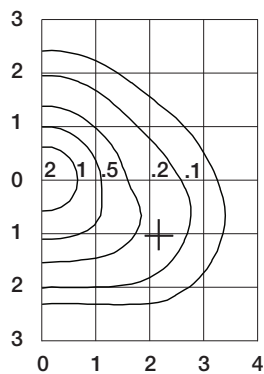
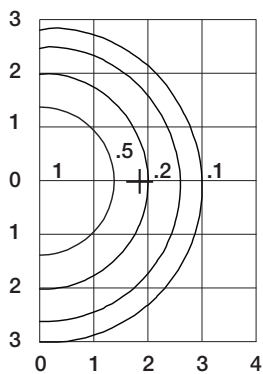

### 100W Type V & III Dome

100W 50-5-D Dome Lens

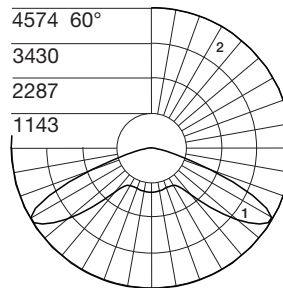

100W 50-3-D Dome Lens

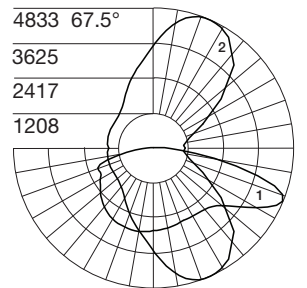

Isofootcandle Lines of Horizontal Illuminance. 25ft Mounting Height

